

# MK CARDAN

ALBERI CARDANICI

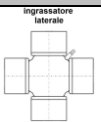

Dimensione Crociere: 34.90x106.30

MdB= 3500 Nm

End Joke 148

MdG= 5000 Nm

<b>Esecuzione</b> <b>Codice</b> <b>OJ42</b> <b>End Joke</b>		<b>Allungamento standard</b> <b>La=70 mm</b>
		<b>Tubo d6+S</b> <b>76.2x2.41 / 88.9x2.41</b> <b>100x2.5 / 120x3</b>
		<b>Ingombro</b> <b>Rotazione 122mm</b>

<b>Esecuzione</b> <b>Codice</b> <b>OJ46</b> <b>End Joke</b>		<b>Alto Allungamento</b> <b>La=100 mm</b>
		<b>Tubo d6+S</b> <b>76.2x2.41 / 88.9x2.41</b> <b>100x2.5 / 120x3</b>
		<b>Ingombro</b> <b>Rotazione 122mm</b>

<b>Esecuzione</b> <b>Codice</b> <b>OJ56</b> <b>End Joke</b>		<b>Alto Allungamento</b> <b>La=250 mm</b>
		<b>Tubo d6+S</b> <b>76.2x2.41 / 88.9x2.41</b> <b>100x2.5 / 120x3</b>
		<b>Ingombro</b> <b>Rotazione 122mm</b>

Lz. Minima realizzabile per:			
$\beta$ max	La=70	La=100	La=250
25°	300	300	480

- Lz le Lunghezze Superiori Sono Tutte Realizzabili

# MK CARDAN

ALBERI CARDANICI



ingrassatore laterale

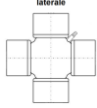

ingrassatore sui cuscinetti

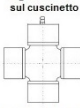

long-life

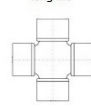

Dimensione Crociere: 34.9x106.3

MdB= 3500 Nm

End Joke 148

MdG= 5000 Nm

Esecuzione  
Codice OJ39  
End Joke

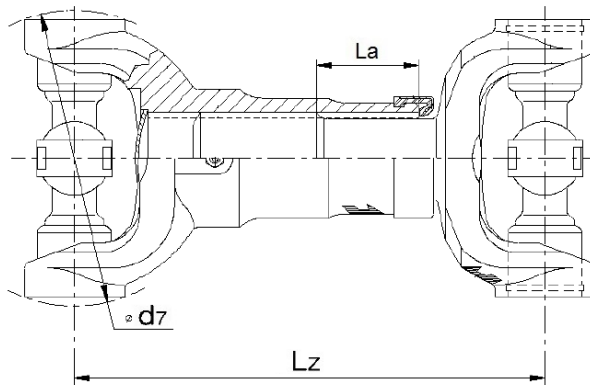

Attacco	$\beta$ max	Lz min realizzabile	La
End Joke	25°	195	30

Esecuzione  
Codice OJ44  
End Joke

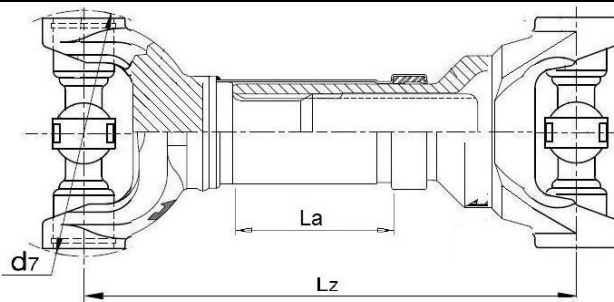

Attacco	$\beta$ max	Lz min realizzabile	La
End Joke	25°	195	30

Codice 60652  
KIT FISSAGGIO CROCIERA

Composto da:  
1 Cavallotto End Joke 1480  
+ 2 VITI UNF.3/8 -24UNF

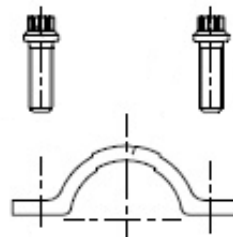

- Lz le Lunghezze Superiori Sono Tutte Realizzabili

- Lunghezze Speciali Extra Corte a Richiesta